

10" Embedded Touch PC v40

FT10V40CAPOB



- Allwinner® V40 Cortex™ A7 QuadCore Processor
 - 2GB RAM Memory & 8GB FLASH Storage ^(v2)
 - Pre-installed Android 6 operating system
 - Anti-glare surface treatment (chemical etching)
 - 10-Finger-Multi Touch Capacitive Touch Panel
 - 1.1mm cover glass with 7H surface hardness
 - Optically bonded Touch Panel to LCD Panel
 - Patented IP65 front with silicon seal
 - Integrated W-LAN module
 - 2 year guarantee (24/7 operation)
- *Optional: integrated GPS, Bluetooth, 3G/4G, POE module*



faytech's Embedded Touch PCs have a pre-installed Android 6 operating system and are equipped with W-LAN module. The device has an IP65 water- and dust proof front panel with capacitive 10-finger multitouch. All the PCs have VESA 75 or VESA 100 screw patterns on the back, while the 13.3" to 27" come with their own desktop stand included.

The Embedded PCs are build for 24/7 operation and powered by the powerful V40 QuadCore mainboard, with 2G DDR3 RAM, 8GB flash memory, a SATA connector and SD card slot for further storage expansion.

This device has an optically bonded touch panel, which will improve the stability, reduce the reflection, increase the viewing angle, and enhance the perceived brightness. It also provides resistance to dust particles and shows a better image in general.

It is the perfect choice for a wide variety of applications, including industrial automation, control panels and digital signage.

Legend / Notes	
Applicable to version 1	(v1)
Applicable to version 2	(v2)
Applicable to all Versions	None

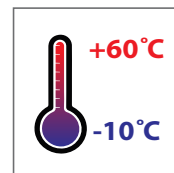

Product name				10" Embedded Touch PC v40			
Model number / EAN number				FT10V40CAPOB / 6920734010813			
Global Article Code	European Article Code	Release date (DIM/Y)	Version	Global Article Code	European Article Code	Release date (DIM/Y)	Version
3030503014	1010501698	01/01/2020	v1				
3030506891	1010502128	18/01/2021	v2				

IP Rating	
IP65 Front / IP40 Back	

LCD Panel	
Screen diagonal (Inch/cm)	9.7/24.64
Display active screen size (cm)	19.7×14.7
Aspect ratio	4:3
Physical resolution	1024×768
External Maximum showable resolution - HDMI	1920×1080
Colours displayed	16.7M
Brightness (cd/m ²)	350
Contrast	800:1
Typical reaction time Tr/ Tf (ms)	10/15
Visual Angle horizontal/vertical (°)	170/170
Backlight / Backlight Lifetime (hours)	LED / 20,000

Operation / Mechanical	
Operating Temperature (°C)	-10 ~ +60
Humidity Range (RH)	10% - 90%
Net weight (kg)	2.00
Gross weight (kg)	2.80 (incl. cartonage)
Housing material	Rubber Frame, Plastic Back Case
Housing (mm) L × W × H	244.9 × 195.8 × 34.0
Cut-out for clamp supports (mm) L × H	N/A
Max. wall thickness for clamp supports (mm)	N/A
Amount of clamps required	N/A
Mounting	VESA 100

Included in the Delivery
Power Supply (see Power section)
W-LAN Antenna (RP-SMA female)
Short Installation Manual

Expansion slots
MiniPCIe

PC System	
CPU	Allwinner® V40 QuadCore
Chipset	Cortex A7
Graphic GPU	ARM® Mali400 Mp2 Complies with OpenGL ES 2.0/1.1
Audio	Integrated HI-FI 100dB Audio Codec Dual analog mic, 2x6W amplifier
Memory	2GB DDR3 ^(v2)
Storage	8GB EMMC Flash
Network	10/100Mbit Network; W-LAN
OS	Android 6

Touch Panel	
Touch Technology	Projected Capacitive 10-Point Multitouch
Touch Connector	USB
Touch Life (Contacts)	Unlimited
Surface Hardness	7H
Surface Treatment	Anti-glare (chemical etching)
Glass Strengthening	Chemically Strengthened

Power	
Power Indicator	Green LED
Power Supply	100-240V ACDC active switching; 12V DC-Out
Working Power (V)	8-18
Power Consumption (W)	9
Stand-By Consumption (W)	<1

Internal Connectors	
1x SD-card	1x SIM-card
2x Serial	4x TTL UART
2x USB 2.0	18/24Bit LVDS
6x GPIO	1x SATA-Port
1x Line-In	1x Line-Out
1x RTC	1x CAN Bus
1x Amplifier for 2x6W loudspeaker	

External Connectors	
1x 8-18V DC-In (screwable)	
1x 10/100Mbit RJ45 Port	
1x W-LAN antenna connector (RP-SMA male)	
1x RJ10 (4P4C)	
2x USB 2.0	1x USB OTG
1x Audio-In	1x Audio-Out
1x HDMI	1x Serial
1x SIM-card slot	1x SD-card slot

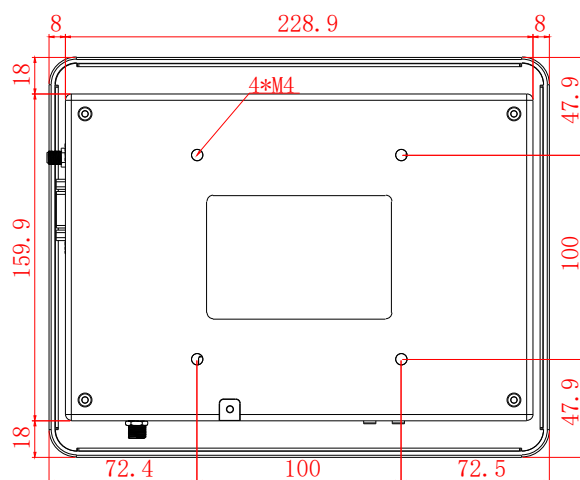
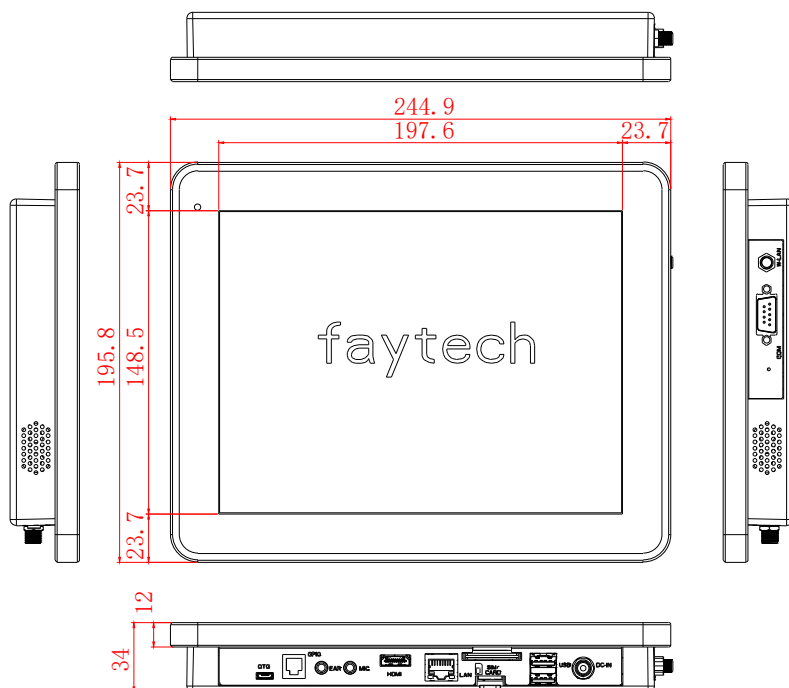

Tolerance: ± 0.5mm

Update Notes:

Version:

v1

-

Changes:

First version

v2

-

Updated the RAM Memory from 1GB to 2GB

Corporate Headquarters

faytech AG

Bischhäuser Aue 10
37213 Witzenhausen
Germany

support@faytech.com
contact@faytech.com
www.faytech.com

China: +86 755 8958 0612
Germany: +49 5542 30374 10
USA: +1 646 843 0877
India: +91 11 49707436
Japan: +81 366 722 920