

15" Capacitive Touch Monitor

FT15TMCAPOB

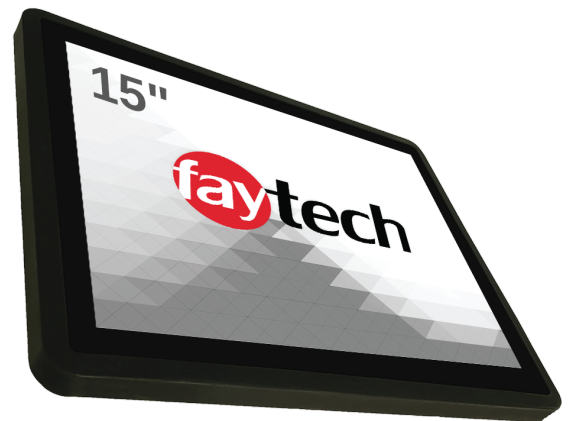

- Anti-glare surface treatment (chemical etching)
- 10-Finger-Multi Touch Capacitive Touch Panel
- 1.1mm cover glass with 7H surface hardness
- Optically bonded Touch Panel to LCD Panel
- Patented IP65 front with silicon seal
- Integrated audio speakers (2x2w)
- 2 year guarantee (24/7 operation)

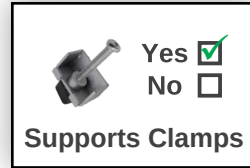

faytech's Capacitive Touch Monitors have a modern sleek look with its flat edge to edge glass IP65 water- and dust proof front panels. This device has capacitive 10-finger multitouch, glass front reaching MosH 7, the glass surface is anti-glare treated (chemical etching) and a wide variety of connectors. All the monitors have VESA 75 or VESA 100 screw patterns on the back, while the 13.3" to 27" come with their own desktop stand included.

This device has an optically bonded touch panel, which will improve the stability, reduce the reflection, increase the viewing angle, and enhance the perceived brightness. It also provides resistance to dust particles and shows a better image in general.

These devices are the perfect choice for a wide variety of applications, including POS systems, control panels in industrial fields, kiosk systems, office/residence automation, digital signage and in areas like shopping malls, classrooms, hotels and many more.

Legend / Notes	
Applicable to version 2	(v2)
Applicable to version 3	(v3)
Applicable to all Versions	None

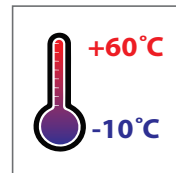
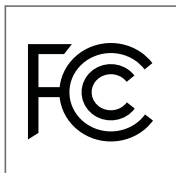
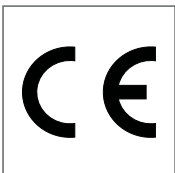

Product name				15" Capacitive Touch Monitor			
Article code / EAN number				FT15TMCAPOB / 6920734015146			
Global Article Code	European Article Code	Release date (DMMY)	Version*	Global Article Code	European Article Code	Release date (DMMY)	Version*
3030501837	1010501572	01/11/2019	v2				
3030509595	1010502310	01/12/2021	v3				

IP Rating	
IP65 Front / IP40 Back	

LCD Panel	
Screen diagonal (Inch/cm)	15/38.10
Display active screen size (cm)	30.40×22.80
Aspect ratio	4:3
Physical resolution	1024×768
Maximum showable resolution	1920×1200
Colours displayed	16.7M
Brightness (cd/m ²)	300
Contrast	700:1
Typical reaction time Tr/ Tf (ms)	8/12
Visual Angle horizontal/vertical (°)	160/160
Backlight / Backlight Lifetime (hours)	LED / 30,000

External Connectors	
Video	1x HDMI 1.3 (incl. HDCP)
	1x DP (v3)
	1x VGA
	1x DVI-D (v2)
Audio	1x PC-Audio
Touch Connector	1x USB
Connectors	1x 12V DC-In (screwable)

Touch Panel	
Touch Technology	Projected Capacitive 10-point Multitouch
Touch Panel Drivers	Windows; Linux; Mac; Android
Touch Life (Contacts)	Unlimited
Surface Hardness	7H
Surface Treatment	Anti-glare (chemical etching)
Glass Strengthening	Chemically Strengthened

Operation / Mechanical	
Operating Temperature (°C)	-10 ~ +60
Humidity Range (RH)	10% - 90%
Net weight (kg)	4.10
Gross weight (kg)	5.10 (incl. cartonage)
Housing material	Rubber front, plastic ABS back case
Housing (mm) L × W × H	359.0 × 291.0 × 45.0
Cut-out for clamp supports (mm) L × H	335.0 × 274.0
Max. wall thickness for clamp supports (mm)	5.0
Amount of clamps required	6
Mounting	VESA 100

Power	
Power Indicator	Green LED
Power Supply	100-240V ACDC active switching; 12V DC-Out
Working Power (V)	12
Power Consumption (W)	13
Stand-By Consumption (W)	<1

Included in the Delivery	
Power Supply (see Power section)	
Short Installation Manual	
Cables - VGA, USB Touch, Audio Cable	
Standard Stand	

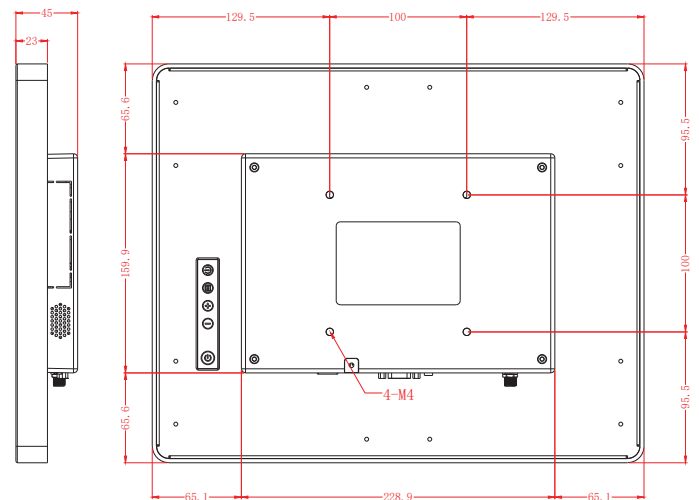
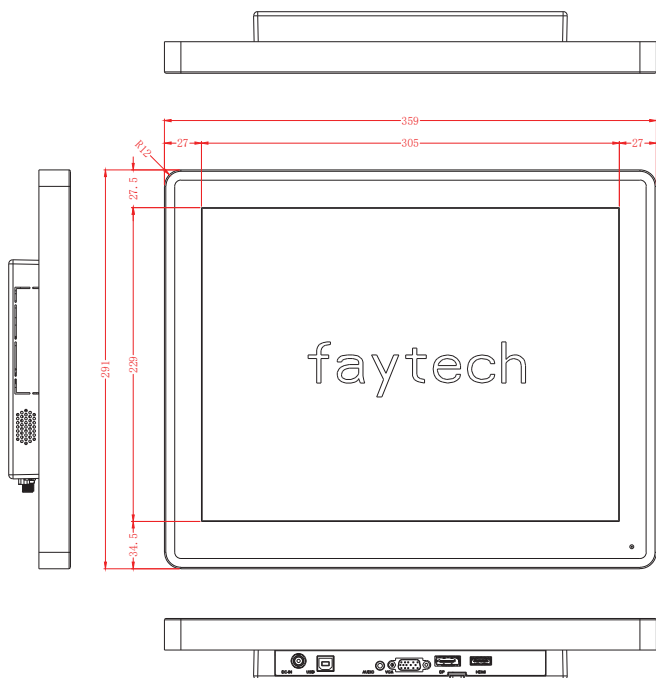

Tolerance: ± 1mm

Update Notes:

* Only the latest version can be ordered, previous versions are only for historic reference.

Version:

Changes:

- v3** - Switching of the DVI-D connector to a DP connector
Housing update (W): 298.0 to 291.0
(v3 drawing on previous page)
- v2** - First version

v2 drawing:

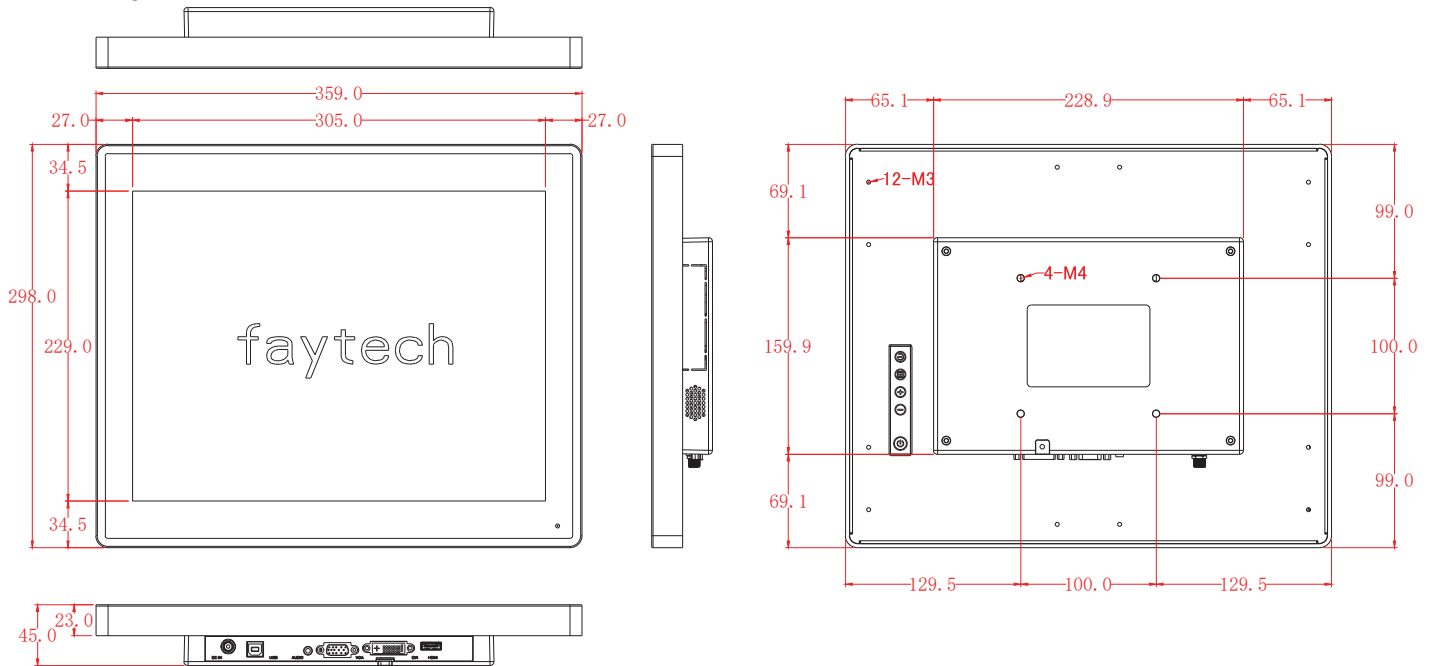

Corporate Headquarters

faytech AG

Bischhäuser Aue 10
37213 Witzenhausen
Germany

support@faytech.com
contact@faytech.com
www.faytech.com

Germany: +49 5542 30374 0

China: +86 755 89580612

USA: +1 646 843 0877

India: +91 11 49707436

Japan: +81 366 722 920

Korea: +82 10 3479 1815